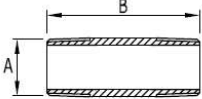
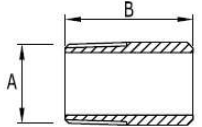
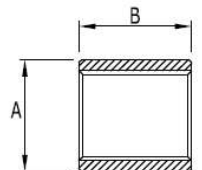
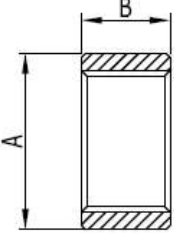
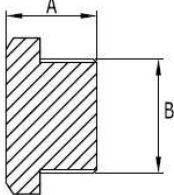
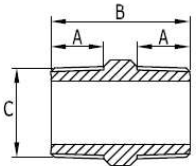

BSP Fittings 150lb

BSP Fittings 150lb						
807A – BSPT Full Barrel Nipple - 150lb 	Size	A	B	TPI	D	Part No
	1/8"	9.7	30	28		807A-B0032
	1/4"	13.2	30	19		807A-B0064
	3/8"	16.7	40	19		807A-B0095
	1/2"	20.9	60	14		807A-B013
	3/4"	26.4	60	14		807A-B019
	1"	33.2	60	11		807A-B026
	1.1/4"	41.9	80	11		807A-B031
	1.1/2"	47.8	80	11		807A-B038
	2"	59.6	100	11		807A-B051
	2.1/2"	75.2	100	11		807A-B064
	3"	87.9	120	11		807A-B076
	4"	113.1	120	11		807A-B102
	• Material – 316SS					
807B – BSPT Weld Nipple - 150lb 	Size	A	B	TPI	D	Part No
	1/8"	9.7	30	28		807B-B0032
	1/4"	13.2	30	19		807B-B0064
	3/8"	16.7	35	19		807B-B0095
	1/2"	20.9	37	14		807B-B013
	3/4"	26.4	38	14		807B-B019
	1"	33.2	40	11		807B-B026
	1.1/4"	41.9	51	11		807B-B031
	1.1/2"	47.8	51	11		807B-B038
	2"	59.6	60	11		807B-B051
	2.1/2"	75.2	64	11		807B-B064
	3"	87.9	70	11		807B-B076
	4"	113.1	70	11		807B-B102
	• Material – 316SS					
807C – BSP Equal Socket - 150lb 	Size	A	B	C	D	Part No
	1/8"	15.9	19			807C-B0032
	1/4"	19.1	27			807C-B0064
	3/8"	22.2	28			807C-B0095
	1/2"	28.6	38			807C-B013
	3/4"	34.9	39			807C-B019
	1"	41.3	46			807C-B026
	1.1/4"	50.8	51			807C-B031
	1.1/2"	57.2	51			807C-B038
	2"	95.3	60			807C-B051
	2.1/2"	98.4	69			807C-B064
	3"	77.8	76			807C-B076
	4"	87.3	87			807C-B102
	• Material – 316SS					

Dimensions are provided in good faith but may be subject to change; if dimensions are critical please call the office to confirm all sizes before placing an order.

BSP Fittings 150lb							
807D – BSP Half Socket - 150lb 	Size	A	B	C	D	Part No	
	1/8"	15.9	10.0			807D-B0032	
	1/4"	19.1	13.0			807D-B0064	
	3/8"	22.2	13.0			807D-B0095	
	1/2"	28.6	16.0			807D-B013	
	3/4"	34.9	19.0			807D-B019	
	1"	41.3	20.5			807D-B026	
	1.1/4"	50.8	25.0			807D-B031	
	1.1/2"	57.2	25.0			807D-B038	
	2"	95.3	28.0			807D-B051	
	2.1/2"	98.4	30.0			807D-B064	
	3"	77.8	35.0			807D-B076	
	4"	87.3	40.0			807D-B102	
	• Material – 316SS						
807E – BSPT Hex Plug - 150lb 	Size	A	B	TPI	D	Part No	
	1/8"	16	9.7	28		807E-B0032	
	1/4"	19	13.2	19		807E-B0064	
	3/8"	22	16.7	19		807E-B0095	
	1/2"	25	20.9	14		807E-B013	
	3/4"	29	26.4	14		807E-B019	
	1"	32	33.2	11		807E-B026	
	1.1/4"	35	41.9	11		807E-B031	
	1.1/2"	37	47.8	11		807E-B038	
	2"	41	59.6	11		807E-B051	
	2.1/2"	49	75.2	11		807E-B064	
	3"	54	87.9	11		807E-B076	
	• Material – 316SS						
	807G – BSPT Full Hex Nipple - 150lb 	Size	A	B	C	TPI	Part No
1/8"		10.0	25.0	9.7	28	807G-B0032	
1/4"		14.2	35.0	13.2	19	807G-B0064	
3/8"		14.2	37.0	16.7	19	807G-B0095	
1/2"		17.5	43.0	20.9	14	807G-B013	
3/4"		19.0	48.0	26.4	14	807G-B019	
1"		20.5	51.0	33.2	11	807G-B026	
1.1/4"		24.0	58.0	41.9	11	807G-B031	
1.1/2"		24.0	60.0	47.8	11	807G-B038	
2"		29.0	72.0	59.6	11	807G-B051	
2.1/2"		32.0	80.0	75.2	11	807G-B064	
3"		35.0	89.0	87.9	11	807G-B076	
4"		41.0	105.0	-	11	807G-B102	
• Material – 316SS							

Dimensions are provided in good faith but may be subject to change; if dimensions are critical please call the office to confirm all sizes before placing an order.

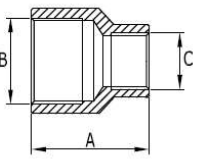
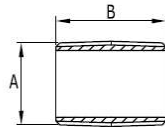
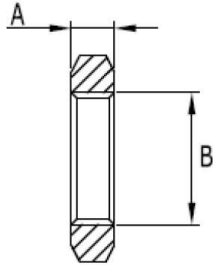
BSP Fittings 150lb						
807H – BSPP Reducing Socket - 150lb 	Size	A	B	C	D	Part No
	1/4" x 1/8"	25	1/4"	1/8"		807H-B006-003
	3/8" x 1/8"	30	3/8"	1/8"		807H-B009-003
	3/8" x 1/4"	30	3/8"	1/4"		807H-B009-006
	1/2" x 1/4"	38	1/2"	1/4"		807H-B013-006
	1/2" x 3/8"	38	1/2"	3/8"		807H-B013-009
	3/4" x 3/8"	41	3/4"	3/8"		807H-B019-009
	3/4" x 1/2"	41	3/4"	1/2"		807H-B019-013
	1" x 1/2"	51	1"	1/2"		807H-B026-013
	1" x 3/4"	51	1"	3/4"		807H-B026-019
	1.1/4" x 3/4"	57	1.1/4"	3/4"		807H-B031-019
	1.1/4" x 1"	57	1.1/4"	1"		807H-B031-026
	1.1/2" x 1"	62	1.1/2"	1"		807H-B038-026
	1.1/2" x 1.1/4"	62	1.1/2"	1.1/4"		807H-B038-031
	2" x 1.1/4"	65	2"	1.1/4"		807H-B051-031
	2" x 1.1/2"	65	2"	1.1/2"		807H-B051-038
	• Material – 316SS					
807I – BSPT Close Barrel Nipple - 150lb 	Size	A	B	C	TPI	Part No
	1/8"	9.7	18		28	807I-B0032
	1/4"	13.2	27		19	807I-B0064
	3/8"	16.7	27		19	807I-B0095
	1/2"	20.9	34		14	807I-B013
	3/4"	26.4	37		14	807I-B019
	1"	33.2	41		11	807I-B026
	1.1/4"	41.9	48		11	807I-B031
	1.1/2"	47.8	48		11	807I-B038
	2"	59.6	57		11	807I-B051
	2.1/2"	75.2	64		11	807I-B064
	3"	87.9	70		11	807I-B076
	• Material – 316SS					
807K – BSPP Hex Back Nut 	Size	A	B	C	D	Part No
	1/8"	6.5	8.6			807K-B0032
	1/4"	6.5	11.5			807K-B0064
	3/8"	8.0	15.0			807K-B0095
	1/2"	8.0	18.6			807K-B013
	3/4"	9.5	24.1			807K-B019
	1"	9.5	30.3			807K-B026
	1.1/4"	11.0	39.0			807K-B031
	1.1/2"	12.0	44.9			807K-B038
	2"	13.0	56.7			807K-B051
	2.1/2"	17.5	72.2			807K-B064
	3"	20.5	84.9			807K-B076
	4"	22.0	110.1			807K-B102
• Material – 316SS						

Dimensions are provided in good faith but may be subject to change; if dimensions are critical please call the office to confirm all sizes before placing an order.

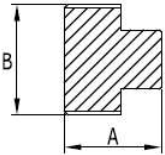
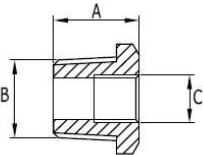
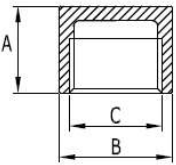
BSP Fittings 150lb							
807L – BSPT Square Head Plug - 150lb 	Size	A	B	C	D	Part No	
	¼"	19	13.2			807L-B0064	
	⅜"	24	16.7			807L-B0095	
	½"	27	20.9			807L-B013	
	¾"	32	26.4			807L-B019	
	1"	35	33.2			807L-B026	
	1.¼"	40	41.9			807L-B031	
	1.½"	40	47.8			807L-B038	
	2"	46	59.6			807L-B051	
	2.½"	52	75.2			807L-B064	
	3"	57	87.9			807L-B076	
	• Material – 316SS						
	807M – BSPT Hex Reducing Bush - 150lb 	Size	A	B	C	D	Part No
¼" x ⅛"		19	¼"	⅛"		807M-B0064-0032	
⅜" x ¼"		22	⅜"	¼"		807M-B0095-0064	
½" x ¼"		25	½"	¼"		807M-B013-0064	
½" x ⅜"		25	½"	⅜"		807M-B013-0095	
¾" x ⅜"		29	¾"	⅜"		807M-B019-0095	
¾" x ½"		29	¾"	½"		807M-B019-013	
1" x ½"		32	1"	½"		807M-B026-013	
1" x ¾"		32	1"	¾"		807M-B026-019	
1.¼" x ¾"		35	1.¼"	¾"		807M-B031-019	
1.¼" x 1"		35	1.¼"	1"		807M-B031-026	
1.½" x 1"		37	1.½"	1"		807M-B038-026	
1.½" x 1.¼"		37	1.½"	1.¼"		807M-B038-031	
2" x 1.¼"		41	2"	1.¼"		807M-B051-031	
2" x 1.½"		41	2"	1.½"		807M-B051-038	
• Material – 316SS							
807V – BSPP End Cap - 150lb 	Size	A	B	C	D	Part No	
	¼"	22	19	11.5		807V-B0064	
	⅜"	22	25	15.0		807V-B0095	
	½"	25	29	18.6		807V-B013	
	¾"	30	35	24.1		807V-B019	
	1"	35	41	30.3		807V-B026	
	1.¼"	40	51	39.0		807V-B031	
	1.½"	41	57	44.9		807V-B038	
	2"	45	70	56.7		807V-B051	
	2.½"	48	89	72.2		807V-B064	
3"	54	101	84.9		807V-B076		
• Material – 316SS							

Dimensions are provided in good faith but may be subject to change; if dimensions are critical please call the office to confirm all sizes before placing an order.

BSP Fittings 150lb

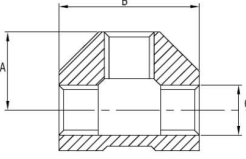
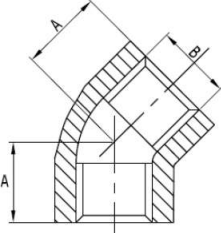
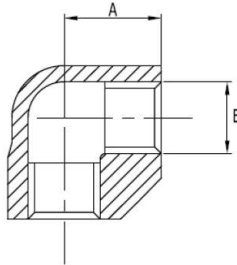
BSP Fittings 150lb						
807T – BSPP Equal Tee - 150lb 	Size	A	B	C	D	Part No
	1/8"	17	34			807T-B0032
	1/4"	19	38			807T-B0064
	3/8"	25	50			807T-B0095
	1/2"	28	56			807T-B013
	3/4"	33	66			807T-B019
	1"	38	76			807T-B026
	1.1/4"	45	90			807T-B031
	1.1/2"	48	96			807T-B038
	2"	56	112			807T-B051
	2.1/2"	69	138			807T-B064
	3"	78	156			807T-B076
	• Material – 316SS					
807R – BSPP Elbow 45° - 150lb 	Size	A	B	C	D	Part No
	1/8"	16.0	8.6			807R-B0032
	1/4"	17.5	11.5			807R-B0064
	3/8"	19.0	15.0			807R-B0095
	1/2"	22.0	18.6			807R-B013
	3/4"	27.0	24.1			807R-B019
	1"	33.0	30.3			807R-B026
	1.1/4"	38.0	39.0			807R-B031
	1.1/2"	44.0	44.9			807R-B038
	2"	51.0	56.7			807R-B051
• Material – 316SS						
807S – BSPP Elbow 90° - 150lb 	Size	A	B	C	D	Part No
	1/8"	17.5	8.6			807S-B0032
	1/4"	19.0	11.5			807S-B0064
	3/8"	25.0	15.0			807S-B0095
	1/2"	28.0	18.6			807S-B013
	3/4"	34.0	24.1			807S-B019
	1"	38.0	30.3			807S-B026
	1.1/4"	45.0	39.0			807S-B031
	1.1/2"	48.0	44.9			807S-B038
	2"	57.0	56.7			807S-B051
	2.1/2"	70.0	72.2			807S-B064
	3"	76.0	84.9			807S-B076
	4"	96.0	110.1			807S-B102
• Material – 316SS						

Dimensions are provided in good faith but may be subject to change; if dimensions are critical please call the office to confirm all sizes before placing an order.

DS: BSP Fittings 150lb V1.1

Page No: 5

BSP Fittings 150lb

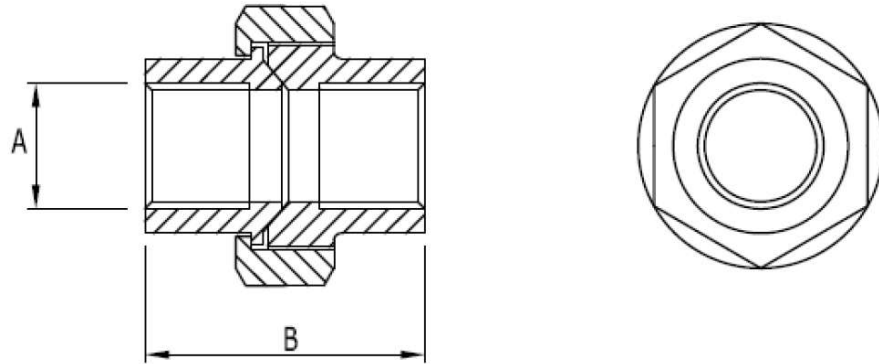

807Q – BSPP Cone Seat Union - 150lb	Size	A	B	Part No	
Options: <ul style="list-style-type: none"> Female x Female Male x Male Male x Female Socket Weld 	1/8"	8.6	35.0	807G-B0032	
	1/4"	11.5	38.0	807G-B0064	
	3/8"	15.0	41.0	807G-B0095	
	1/2"	18.6	47.5	807G-B013	
	3/4"	24.1	51.0	807G-B019	
	1"	30.3	54.0	807G-B026	
	1.1/4"	39.0	63.5	807G-B031	
	1.1/2"	44.9	73.0	807G-B038	
	2"	56.7	78.0	807G-B051	
	2.1/2"	72.2	82.5	807G-B064	
	3"	84.9	92.0	807G-B076	
					<ul style="list-style-type: none"> Material – 316SS

Dimensions are provided in good faith but may be subject to change; if dimensions are critical please call the office to confirm all sizes before placing an order.

DS: BSP Fittings 150lb V1.1

Page No: 6