

## DIN 11851 Hygienic Union & 11852 Fittings

The DIN 11851 union is widely used throughout Europe and the Middle East and incorporates a round slotted nut and D Section seal, as standard. The union is manufactured to suit Imperial tube sizes from 1" to 4" and also to suit DIN 11850 metric tube from 10mm to 200mm, as standard. Two seal designs are offered for the union, namely the flush fitting and crevice free lipped seal and the more common, D section seal. A thicker section of seal is also available for high pressure applications and to compensate for minor pipeline misalignment.

The standard seal material is Nitrile/Perbunan (Buna) and is generally blue or grey in colour, while alternatives in FKM®, EPDM, PTFE and translucent silicone are also available.

The male features an inverted cone face that carries the seal, whilst the liner is similarly conical with a flat face to effect a clean hygienic joint.

### Working Pressure Range, (Fully Forged Unions):

DN 10 - DN 40	Max. Working Pressure 40 Bar @ 20°C
DN 50 - DN 100	Max. Working Pressure 25 Bar @ 20°C
DN 125 - DN 150	Max. Working Pressure 16 Bar @ 20°C

### Size Ranges:

Imperial: 1" to 4".  
Metric: 10mm to 200mm.

### Seal Design:

D Section - Unlipped  
D Section - Unlipped (Oversized)  
P Section - Lipped

### Accessories:

Blank Nuts and Chains  
Cone Strainers  
Bends, Tees and Reducers  
EPDM, Nitrile, FKM®, PTFE & PTFE Envelope  
C Spanner  
Pipe Clips and U Bolts  
Fabricated Bends, Tees and Manifolds  
Filters, Screens and Sampling Equipment



### Full range of Butterfly Valves, Ball Valves, Pressure Relief and Non-Return

### Associated standards:

• DIN 11853	-	Aseptic Union Screwed
• DIN 11852	-	Hygienic Fittings, Metric
• DIN 11850	-	Hygienic Tube, Metric
• DIN 11864-1	-	Aseptic Union Screwed
• DIN 11864-2	-	Aseptic Union Flanged
• DIN 11864-3	-	Aseptic Union Tri-Clamp
• DIN 11866	-	Pharmaceutical Tube, Metric
• ASME BPE	-	Pharmaceutical Tube, Imperial
• ISO 2037	-	Stainless Steel Tubes for the Food Industry
• ASTM A270	-	Stainless Steel Tube for Sanitary, Dairy and Food Industries
• ASTM A312	-	Stainless Steel Pipe for High Temperature and General uses
• ISO 1127	-	Stainless Steel Tubes
• ISO 2851	-	Stainless Steel Bends and Tees for the Food Industry
• SMS 3008	-	Stainless Steel Tubes
• SMS 3017	-	Stainless Steel Tubes

Dimensions are provided in good faith but may be subject to change; if dimensions are critical please call the office to confirm all sizes before placing an order.

DS: DIN11851\_50\_52\_V1.6

Page No: 1

NB: Please check with the technical department all dimensions at the time of enquiry.

### DIN 11851 Hygienic Union – Metric

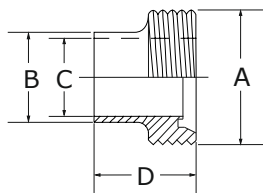
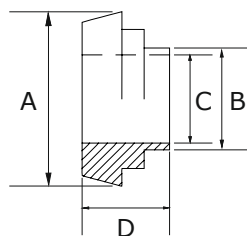
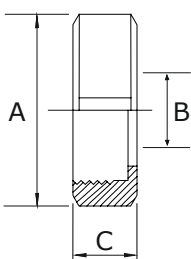
<b>DIN 11851 Weld Male - 316L</b>	Size	A	B	C	D	Part No
	10	28	13	10	21	6061-A010
	15	34	19	16	21	6061-A015
	20	44	23	20	24	6061-A020
	25	52	29	26	29	6061-A025
	32	58	35	32	32	6061-A032
	40	65	41	38	33	6061-A040
	50	78	53	50	35	6061-A050
	65	95	70	66	40	6061-A065
	75	104	76	72	40	6061-A075
	80	110	85	81	45	6061-A080
	100	130	104	100	54	6061-A100
	125	160	129	125	46	6061-A125
	150	190	154	150	50	6061-A150
<b>DIN 11851 Weld Liner - 316L</b>	Size	A	B	C	D	Part No
	10	22.5	13	10	17	6063-A010
	15	28.5	19	16	17	6063-A015
	20	36.5	23	20	18	6063-A020
	25	44.0	29	26	22	6063-A025
	32	50.0	35	32	25	6063-A032
	40	56.0	41	38	26	6063-A040
	50	68.5	53	50	28	6063-A050
	65	86.0	70	66	32	6063-A065
	3"	93.0	76	72	32	6063-A075
	80	100.0	85	81	37	6063-A080
	100	121.0	104	100	44	6063-A100
	125	150.0	129	125	34	6063-A125
	150	176.0	154	150	37	6063-A150
<b>DIN 11851 Round Slotted Nut - 304</b>	Size	A	B	C	Part No	
	10	38	19.0	18	6064-C010	
	15	44	25.0	18	6064-C015	
	20	54	31.0	20	6064-C020	
	25	63	36.0	21	6064-C025	
	32	70	42.0	21	6064-C032	
	40	78	49.0	21	6064-C040	
	50	92	62.0	22	6064-C050	
	65	112	80.0	25	6064-C065	
	3"	120	86.5	26	6064-C075	
	80	127	94.0	30	6064-C080	
	100	148	115.0	31	6064-C100	
	125	178	138.0	35	6064-C125	
	150	210	164.0	40	6064-C150	
	200	260	214.0	40	6064-C200	

Dimensions are provided in good faith but may be subject to change; if dimensions are critical please call the office to confirm all sizes before placing an order.

## DIN 11851 Hygienic Union – Metric

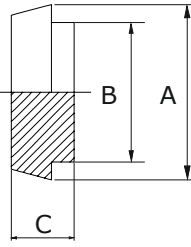
<b>DIN 11851 Blank Liner Machined – 316L</b>  	Size	A	B	C	Part No
	10	22.5	18	9.0	606C-A010
15	28.5	24	9.0	606C-A015	
20	36.5	30	11.0	606C-A020	
25	44.0	35	13.0	606C-A025	
32	50.0	41	13.0	606C-A032	
40	56.0	48	13.0	606C-A040	
50	68.5	61	14.0	606C-A050	
65	86.0	79	16.0	606C-A065	
3"	93.0	86	16.0	606C-A075	
80	100.0	93	16.0	606C-A080	
100	121.0	114	20.0	606C-A100	
125	150.0	137	22.0	606C-A125	
150	176.0	163	24.0	606C-A150	

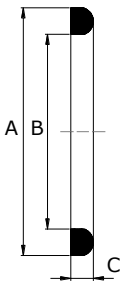
<b>DIN 11851 Seal Unlipped</b>  	Size	A	B	C	Part No PTFE	Part No EPDM	Part No FKM	Part No Nitrile
	10	20	12	4.5	6034-T010	6034-E010	6034-V010	6034-N010
15	26	18	4.5	6034-T015	6034-E015	6034-V015	6034-N015	
20	33	23	4.5	6034-T020	6034-E020	6034-V020	6034-N020	
25	40	30	5.0	6034-T025	6034-E025	6034-V025	6034-N025	
32	46	36	5.0	6034-T032	6034-E032	6034-V032	6034-N032	
40	52	42	5.0	6034-T040	6034-E040	6034-V040	6034-N040	
50	64	54	5.0	6034-T050	6034-E050	6034-V050	6034-N050	
65	81	71	5.0	6034-T065	6034-E065	6034-V065	6034-N065	
3"	88	78	5.0	6034-T075	6034-E075	6034-V075	6034-N075	
80	95	85	5.0	6034-T080	6034-E080	6034-V080	6034-N080	
90	104	94	5.0	6034-T090	6034-E090	6034-V090	6034-N090	
100	114	104	6.0	6034-T100	6034-E100	6034-V100	6034-N100	
125	142	130	7.0	6034-T125	6034-E125	6034-V125	6034-N125	
150	167	155	7.0	6034-T150	6034-E150	6034-V150	6034-N150	
200	216	204	7.0	6034-T200	6034-E200	6034-V200	6034-N200	
					Other gasket materials are available. For a full list of materials or for special seal requirements please enquire.			

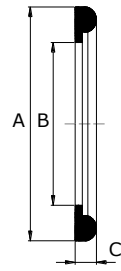
<b>DIN 11851 Seal Lipped</b>  	Size	A	B	C	Part No PTFE	Part No EPDM	Part No FKM	Part No Nitrile
	10	20	10.5	5	6035-T010	6035-E010	6035-V010	6035-N010
15	26	16.5	5	6035-T015	6035-E015	6035-V015	6035-N015	
20	33	20.5	5	6035-T020	6035-E020	6035-V020	6035-N020	
25	40	26.5	6	6035-T025	6035-E025	6035-V025	6035-N025	
32	46	32.5	6	6035-T032	6035-E032	6035-V032	6035-N032	
40	52	38.5	6	6035-T040	6035-E040	6035-V040	6035-N040	
50	64	50.5	6	6035-T050	6035-E050	6035-V050	6035-N050	
65	81	66.5	6	6035-T065	6035-E065	6035-V065	6035-N065	
75	88	74.5	6	-	6035-E075	-	6035-N075	
80	95	81.5	6	6035-T080	6035-E080	6035-V080	6035-N080	
100	114	100.5	6	6035-T100	6035-E100	6035-V100	6035-N100	
125	142	125.0	7	6035-T125	6035-E125	6035-V125	6035-N125	
150	167	150.0	7	6035-T150	6035-E150	6035-V150	6035-N150	
					Other gasket materials are available. For a full list of materials or for special seal requirements please enquire.			

Dimensions are provided in good faith but may be subject to change; if dimensions are critical please call the office to confirm all sizes before placing an order.

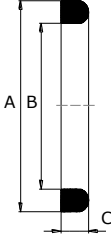
<b>DIN 11851 Hygienic Union – Metric</b>							
<p><b>DIN 11851 Seal Thick Section</b></p> 	Size	A	B	C	Part No EPDM	Part No FKM	Part No Nitrile
	20	33	23	8	6036-E020	6036-V020	6036-N020
	25	40	30	8	6036-E025	6036-V025	6036-N025
	32	46	36	8	6036-E032	6036-V032	6036-N032
	40	52	42	8	6036-E040	6036-V040	6036-N040
	50	64	54	8	6036-E050	6036-V050	6036-N050
	65	81	71	8	6036-E065	6036-V065	6036-N065
	75	88	78	8	6036-E075	6036-V075	6036-N075
	80	95	85	8	6036-E080	6036-V080	6036-N080
	100	114	104	8	6036-E100	6036-V100	6036-N100
	125	142	130	8	6036-E125	6036-V125	6036-N125
	150	167	155	8	6036-E150	6036-V150	6036-N150

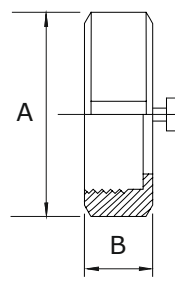
<p><b>DIN 11851 Blank Nut Slotted - 304</b></p> 	Size	A	B	Part No
	10	38	18.5	606A-C010
	15	44	18.5	606A-C015
	20	54	20.5	606A-C020
	25	63	21.5	606A-C025
	32	70	21.5	606A-C032
	40	78	21.5	606A-C040
	50	92	22.5	606A-C050
	65	112	25.5	606A-C065
	3"	119	25.5	606A-C075
	80	127	29.5	606A-C080
	100	148	31.5	606A-C100
	125	178	34.5	606A-C125
	150	210	40.5	606A-C150
				Chains and a Disc seal are also available

Dimensions are provided in good faith but may be subject to change; if dimensions are critical please call the office to confirm all sizes before placing an order.

## DIN 11852 Welding Fittings

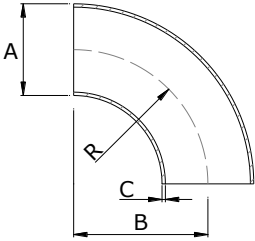
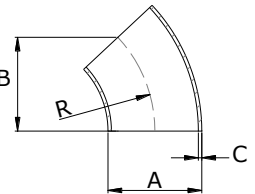
<b>Weld Bend 90°</b>	Size	A	B	C	R	Part No
	10	13	26.0	1.5	26.0	605C-A010
	15	19	35.0	1.5	35.0	605C-A015
	20	23	40.0	1.5	40.0	605C-A020
	25	29	50.0	1.5	50.0	605C-A025
	32	35	55.0	1.5	55.0	605C-A032
	40	40	60.0	1.5	60.0	605C-A040
	50	53	70.0	1.5	70.0	605C-A050
	65	70	80.0	2.0	80.0	605C-A065
	80	85	90.0	2.0	90.0	605C-A080
	100	104	100.0	2.0	100.0	605C-A100
	125	129	187.5	2.0	187.5	605C-A125
	150	154	225.0	2.0	225.0	605C-A150
	200	204	300.0	2.0	300.0	605C-A200
	250	254	375.0	2.0	375.0	605C-A250
	<b>Weld Bend 45°</b>	Size	A	B	C	R
	10	13	17	1.5	26.0	605E-A010
	15	19	23	1.5	35.0	605E-A015
	20	23	27	1.5	40.0	605E-A020
	25	29	34	1.5	50.0	605E-A025
	32	35	37	1.5	55.0	605E-A032
	40	41	41	1.5	60.0	605E-A040
	50	53	48	1.5	70.0	605E-A050
	65	70	55	2.0	80.0	605E-A065
	80	85	62	2.0	90.0	605E-A080
	100	104	69	2.0	100.0	605E-A100
	125	129	131	2.0	187.5	605E-A125
	150	154	157	2.0	225.0	605E-A150
	200	204	300	2.0	300.0	605E-A200

Dimensions are provided in good faith but may be subject to change; if dimensions are critical please call the office to confirm all sizes before placing an order.

DS: DIN11851\_50\_52\_V1.6

Page No: 5



## DIN 11852 Welding Fittings

### Tee Piece - Short Neck - 316L

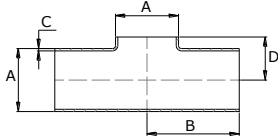

Size	A	B	C	D	Part No
10	13	26.0	1.5	7.5	605G-A010
15	19	35.0	1.5	11.0	605G-A015
20	23	40.0	1.5	12.0	605G-A020
25	29	50.0	1.5	16.0	605G-A025
32	35	55.0	1.5	19.5	605G-A032
40	41	60.0	1.5	23.0	605G-A040
50	53	70.0	1.5	30.0	605G-A050
65	70	80.0	2.0	40.0	605G-A065
80	85	90.0	2.0	47.5	605G-A080
100	104	100.0	2.0	58.0	605G-A100
125	129	187.5	2.0	71.5	605G-A125
150	154	225.0	2.0	87.0	605G-A150
200	204	300.0	2.0	112.0	605G-A200

### Tee Piece - Equal - 316L

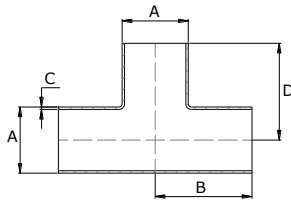

Size	A	B	C	D	Part No
10	13	26.0	1.5	26.0	605J-A010
15	19	35.0	1.5	35.0	605J-A015
20	23	40.0	1.5	40.0	605J-A020
25	29	50.0	1.5	50.0	605J-A025
32	35	55.0	1.5	55.0	605J-A032
40	41	60.0	1.5	60.0	605J-A040
50	53	70.0	1.5	70.0	605J-A050
65	70	80.0	2.0	80.0	605J-A065
80	85	90.0	2.0	90.0	605J-A080
100	104	100.0	2.0	100.0	605J-A100
125	129	187.5	2.0	187.5	605J-A125
150	154	225.0	2.0	225.0	605J-A150
200	204	300.0	2.0	300.0	605J-A200

Dimensions are provided in good faith but may be subject to change; if dimensions are critical please call the office to confirm all sizes before placing an order.

DS: DIN11851\_50\_52\_V1.6

Page No: 6

## DIN 11852 Pulled Reducing Tee – 316L

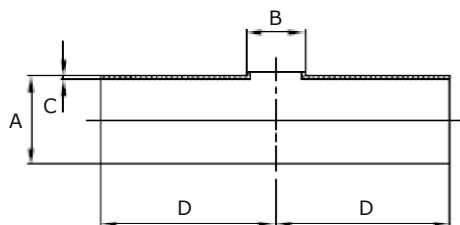

Size	A	B	C	D	Part No
40/20	41	20	1.5	60	605H-A040-020
40/25	41	26	1.5	60	605H-A040-025
40/32	41	32	1.5	60	605H-A040-032
50/20	53	20	1.5	70	605H-A050-020
50/25	53	26	1.5	70	605H-A050-025
50/32	53	32	1.5	70	605H-A050-032
50/40	53	38	1.5	70	605H-A050-040
65/25	70	26	2.0	80	605H-A065-025
65/32	70	32	2.0	80	605H-A065-032
65/40	70	38	2.0	80	605H-A065-040
65/50	70	50	2.0	80	605H-A065-050
80/25	85	26	2.0	90	605H-A080-025
80/32	85	32	2.0	90	605H-A080-032
80/40	85	38	2.0	90	605H-A080-040
80/50	85	50	2.0	90	605H-A080-050
80/65	85	66	2.0	90	605H-A080-065
100/25	104	26	2.0	100	605H-A100-025
100/32	104	32	2.0	100	605H-A100-032
100/40	104	38	2.0	100	605H-A100-040
100/50	104	50	2.0	100	605H-A100-050
100/65	104	66	2.0	100	605H-A100-065
100/80	104	81	2.0	100	605H-A100-080
125/25	129	26	2.0	187	605H-A125-025
125/32	129	32	2.0	187	605H-A125-032
125/40	129	38	2.0	187	605H-A125-040
125/50	129	50	2.0	187	605H-A125-050
125/65	129	66	2.0	187	605H-A125-065
125/80	129	81	2.0	187	605H-A125-080
125/100	129	100	2.0	187	605H-A125-100
150/25	154	26	2.0	225	605H-A150-025
150/40	154	38	2.0	225	605H-A150-040
150/50	154	50	2.0	225	605H-A150-050
150/65	154	66	2.0	225	605H-A150-065
150/80	154	81	2.0	225	605H-A150-080
150/100	154	100	2.0	225	605H-A150-100
150/125	154	125	2.0	225	605H-A150-125

Dimensions are provided in good faith but may be subject to change; if dimensions are critical please call the office to confirm all sizes before placing an order.

DS: DIN11851\_50\_52\_V1.6

Page No: 7

## DIN 11852 Welding Fittings

### Concentric Reducer - 316L

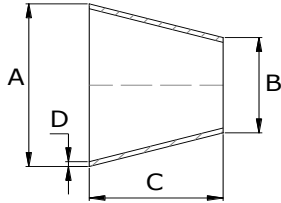

Size	A	B	C	D Wall (mm)	Part No
15-10	19	13	11	1.5	605L-A015-010
20-10	23	13	18	1.5	605L-A020-010
20-15	23	19	7	1.5	605L-A020-015
25-10	29	13	28	1.5	605L-A025-010
25-15	29	19	18	1.5	605L-A025-015
25-20	29	23	11	1.5	605L-A025-020
32-15	35	19	28	1.5	605L-A032-015
32-20	35	23	22	1.5	605L-A032-020
32-25	35	29	11	1.5	605L-A032-025
40-20	41	23	33	1.5	605L-A040-020
40-25	41	29	22	1.5	605L-A040-025
40-32	41	35	11	1.5	605L-A040-032
50-25	53	29	44	1.5	605L-A050-025
50-32	53	35	33	1.5	605L-A050-032
50-40	53	41	22	1.5	605L-A050-040
65-32	70	35	62	2.0	605L-A065-032
65-40	70	41	51	2.0	605L-A065-040
65-50	70	53	29	2.0	605L-A065-050
80-40	85	41	78	2.0	605L-A080-040
80-50	85	53	56	2.0	605L-A080-050
80-65	85	70	27	2.0	605L-A080-065
100-50	104	53	90	2.0	605L-A100-050
100-65	104	70	61	2.0	605L-A100-065
100-80	104	85	34	2.0	605L-A100-080
125-65	129	70	106	2.0	605L-A125-065
125-80	129	85	79	2.0	605L-A125-080
125-100	129	104	45	2.0	605L-A125-100
150-80	154	85	124	2.0	605L-A150-080
150-100	154	104	90	2.0	605L-A150-100
150-125	154	129	45	2.0	605L-A150-125
200-150	204	154	90	2.0	605L-A200-150

Dimensions are provided in good faith but may be subject to change; if dimensions are critical please call the office to confirm all sizes before placing an order.



## DIN 11852 Welding Fittings

### Eccentric Reducer – 316L

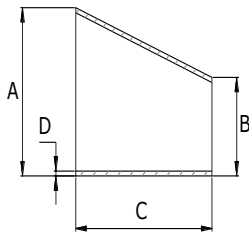

Size	A	B	C	D	Part No
15-10	19	13	16.5	1.5	<a href="#">605N-A015-010</a>
20-10	23	13	27.5	1.5	<a href="#">605N-A020-010</a>
20-15	23	19	11.0	1.5	<a href="#">605N-A020-015</a>
25-10	29	13	44.0	1.5	<a href="#">605N-A025-010</a>
25-15	29	19	27.5	1.5	<a href="#">605N-A025-015</a>
25-20	29	23	16.5	1.5	<a href="#">605N-A025-020</a>
32-15	35	19	44.0	1.5	<a href="#">605N-A032-015</a>
32-20	35	23	33.0	1.5	<a href="#">605N-A032-020</a>
32-25	35	29	16.5	1.5	<a href="#">605N-A032-025</a>
40-15	41	19	60.5	1.5	<a href="#">605N-A040-015</a>
40-20	41	23	49.5	1.5	<a href="#">605N-A040-020</a>
40-25	41	29	33.0	1.5	<a href="#">605N-A040-025</a>
40-32	41	35	16.5	1.5	<a href="#">605N-A040-032</a>
50-25	53	29	66.0	1.5	<a href="#">605N-A050-025</a>
50-32	53	35	49.5	1.5	<a href="#">605N-A050-032</a>
50-40	53	41	33.0	1.5	<a href="#">605N-A050-040</a>
65-40	70	41	77.0	2.0	<a href="#">605N-A065-040</a>
65-50	70	53	44.0	2.0	<a href="#">605N-A065-050</a>
80-50	85	53	85.0	2.0	<a href="#">605N-A080-050</a>
80-65	85	70	41.2	2.0	<a href="#">605N-A080-065</a>
100-50	104	53	137.5	2.0	<a href="#">605N-A100-050</a>
100-65	104	70	93.5	2.0	<a href="#">605N-A100-065</a>
100-80	104	85	52.5	2.0	<a href="#">605N-A100-080</a>
125-80	129	85	121.0	2.0	<a href="#">605N-A125-080</a>
125-100	129	104	68.5	2.0	<a href="#">605N-A125-100</a>
150-100	154	104	137.5	2.0	<a href="#">605N-A150-100</a>
150-125	154	129	68.5	2.0	<a href="#">605N-A150-125</a>

Dimensions are provided in good faith but may be subject to change; if dimensions are critical please call the office to confirm all sizes before placing an order.

DS: DIN11851\_50\_52\_V1.6

Page No: 9

## Hygienic Stainless Steel Tube

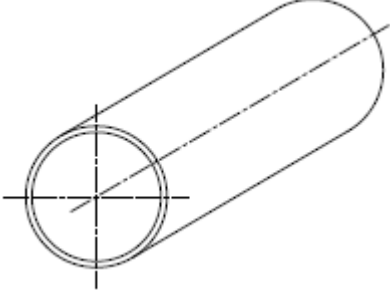
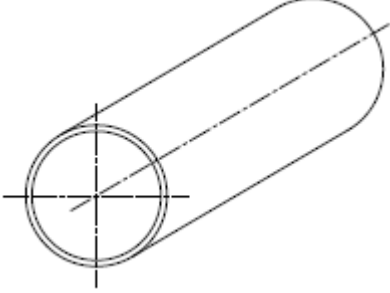
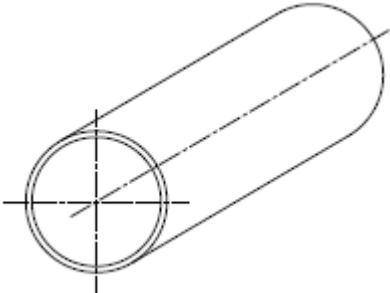
Hygienic Stainless Steel Tube				
<p><b>DIN 11850 - Series 1</b></p> 	Size	OD	Wall (mm)	Part No
	10	12	1.0	N/A
	15	18	1.0	N/A
	20	22	1.0	N/A
	25	28	1.0	N/A
	32	34	1.0	N/A
	40	40	1.0	N/A
	50	52	1.0	N/A
<p><b>DIN 11850 - Series 2</b></p> 	Size	OD	Wall (mm)	Part No
	10	13	1.5	N/A
	15	19	1.5	N/A
	20	23	1.5	N/A
	25	29	1.5	N/A
	32	35	1.5	N/A
	40	41	1.5	N/A
	50	53	1.5	N/A
	65	70	2.0	N/A
	80	85	2.0	N/A
	100	104	2.0	N/A
	125	129	2.0	N/A
	150	154	2.0	N/A
	200	204	2.0	N/A
<p><b>DIN 11850 - Series 3</b></p> 	Size	OD	Wall (mm)	Part No
	10	14	2.0	N/A
	15	20	2.0	N/A
	20	24	2.0	N/A
	25	30	2.0	N/A
	32	36	2.0	N/A
	40	42	2.0	N/A
	50	54	2.0	N/A

Dimensions are provided in good faith but may be subject to change; if dimensions are critical please call the office to confirm all sizes before placing an order.

DS: DIN11851\_50\_52\_V1.6

Page No: 10

## Hygienic Stainless Steel Tube

### DIN EN ISO 1127 - Series 1

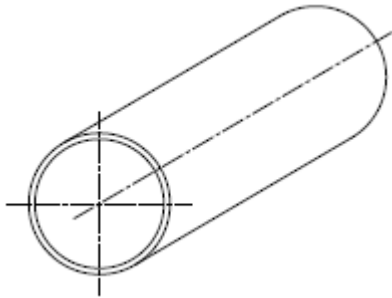

Size	OD	Wall (mm)	Part No
NS10	17.2	1.6	N/A
NS15	21.3	1.6	N/A
NS20	26.9	1.6	N/A
NS25	33.7	2.0	N/A
NS32	42.4	2.0	N/A
NS40	48.2	2.0	N/A
NS50	60.3	2.0	N/A
NS65	76.1	2.3	N/A
NS80	88.9	2.3	N/A
NS100	114.3	2.6	N/A
NS125	139.7	2.6	N/A
NS150	168.3	2.6	N/A
NS200	219.1	2.6	N/A

Dimensions are provided in good faith but may be subject to change; if dimensions are critical please call the office to confirm all sizes before placing an order.

DS: DIN11851\_50\_52\_V1.6

Page No: 11